

*Shanghai SVA - NEC Liquid Crystal Display Co., Ltd.*

## TFT COLOR LCD MODULE

(COMMON)

SVA150XG10TB

38cm (15.0 Type)

XGA

LVDS Interface (1port)

## DATA SHEET

(Version 6.0)

*Published by*

Product Technology Department  
SVA - NEC Liquid Crystal Display Co., Ltd.

*Approved by*

*Date*

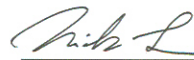

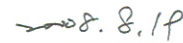

*Checked by*

*Date*

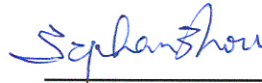

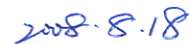

*Prepared by*

*Date*

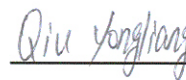

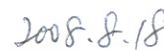

*Signature of customer*

*Confirmed by*

*Date*

## INTRODUCTION

### • WARRANTY

Shanghai SVA NEC Liquid Crystal Display Co., Ltd. (hereinafter called "SVA-NEC") warrants that this product meets the product specifications set forth in this document. If this product under normal operation is found to be non-conforming to the product specifications, and such non-conformance is promptly notified to SVA-NEC within one (1) year after the delivery date, and further such non-conformance is solely attributable to SVA-NEC, SVA-NEC shall repair the non-conforming product or replace it with a conforming one, free of charge. However, this warranty does not apply to any non-conformance that can be found easily by incoming inspections or those resulting from any one of the following:

- 1) Unauthorized or improper repair, maintenance or modification
- 2) Operation or use against specifications, instructions or warnings given by SVA-NEC
- 3) Any other causes attributable to customer

In case SVA-NEC repairs or replaces a product after the one (1)-year warranty period, SVA-NEC shall be entitled to charge for such repair or replacement. Those replaced parts shall be covered with six (6)-month warranty period from the replacement day. Non-conforming products may be replaced with substitutes instead of repair when the manufacture of this product has been terminated.

**EXCEPT AS EXPRESSLY SET FORTH HEREIN, SVA-NEC DISCLAIMS ANY WARRANTIES, EXPRESS OR IMPLIED, INCLUDING BUT NOT LIMITED TO MERCHANTABILITY AND FITNESS FOR A PARTICULAR PURPOSE, AND DISCLAIMS ANY REMEDIES.**

### • MAINTENANCE

The specifications of maintenance parts may be partially changed within equivalent quality or better. In this product, SVA-NEC will not accept to maintain for only mounting parts on circuit board (e.g. connector, fuse, capacitor, resistor, etc.) and only backlight conformation parts (e.g. reflector sheet, light guide plate, etc.).

If SVA-NEC is planning discontinuation for this product, SVA-NEC shall inform it to customers in six (6)-months advance from the issued date of official agreements. In addition, after product discontinuation, SVA-NEC may replace substitutes instead of maintenance parts with whole product.

### • CHANGE CONTROL

For the purpose of product improvement, this product design may be changed for specifications, appearance, parts, circuits and so on. In case a design change is affected on the product specifications, SVA-NEC shall inform it to customers in advance.

### • HANDLING OF DOUBTFUL POINTS

Any question arising out of, or in connection with, this SPECIFICATION or any matter not stipulated herein will be settled each time upon consultation between both parties.

## CONTENTS

INTRODUCTION .....	2
CONTENTS.....	3
1. OUTLINE .....	4
1.1 STRUCTURE AND PRINCIPLE .....	4
1.2 APPLICATIONS .....	4
1.3 FEATURES .....	4
2. GENERAL SPECIFICATIONS .....	5
3. BLOCK DIAGRAM .....	6
4. DETAILED SPECIFICATION .....	7
4.1 MECHANICAL SPECIFICATIONS .....	7
4.2 ABSOLUTE MAXIMUM RATINGS .....	7
4.3 ELECTRICAL CHARACTERISTICS .....	7
4.4 POWER SUPPLY VOLTAGE SEQUENCE .....	9
4.5 CONNECTIONS AND FUNCTIONS FOR INTERFACE PINS .....	10
4.6 DISPLAY COLORS AND INPUT DATA SIGNALS .....	13
4.7 DISPLAY POSITIONS .....	14
4.8 INPUT SIGNAL TIMINGS FOR LCD PANEL SIGNAL PROCESSING BOARD .....	14
4.9 OPTICS .....	17
5. RELIABILITY TESTS .....	19
6. ESTIMATED LUMINANCE LIFETIME .....	20
7. MARKINGS .....	21
7.1 PRODUCT LABEL .....	21
7.2 BARCODE LABEL .....	21
7.3 OTHER MARKINGS .....	21
7.4 INDICATION LOCATIONS .....	22
8. PACKING, TRANSPORTATION AND DELIVERY .....	23
8.1 PACKING .....	23
8.2 INSPECTION RECORD SHEET .....	23
8.3 TRANSPORTATION .....	23
8.4 SIZE AND WEIGHT FOR PACKING BOX .....	23
8.5 OUTLINE FIGURE FOR PACKING .....	24
9. PRECAUTIONS .....	26
9.1 MEANING OF CUTION SIGNS .....	26
9.2 CAUTIONS .....	26
9.3 ATTENTIONS .....	26
10. OUTDRAWING .....	28

## 1. OUTLINE

### 1.1 STRUCTURE AND PRINCIPLE

SVA150XG10TB module is composed of the amorphous silicon thin film transistor liquid crystal display (a-Si TFT LCD) panel structure with driver LSIs for driving the TFT (Thin Film Transistor) array and a backlight.

The a-Si TFT LCD panel structure is injected liquid crystal material into a narrow gap between the TFT array glass substrate and a color-filter glass substrate.

Color (Red, Green, Blue) data signals from a host system (e.g. PC, signal generator, etc.) are modulated into best form for active matrix system by a signal processing board, and sent to the driver LSIs which drive the individual TFT arrays.

The TFT array as an electro-optical switch regulates the amount of transmitted light from the backlight assembly, when it is controlled by data signals. Color images are created by regulating the amount of transmitted light through the TFT array of red, green and blue dots.

### 1.2 APPLICATIONS

- Monitor for PC

### 1.3 FEATURES

- a-Si TFT active matrix
- LVDS interface (6 bit+FRC)
- Wide viewing angle
- high response time : 8ms (typ.)
- PSWG standard
  - High contrast: 600:1(typ.)
- Edge light type backlight (Inverter less)
- RoHS compliance
- TCO'03 compliance

## 2. GENERAL SPECIFICATIONS

<b>Display area</b>	304.128 (W) x 228.096 (H) mm (typ.)
<b>Diagonal size of display</b>	38.0 cm (15.0 inches)
<b>Drive system</b>	a-Si TFT active matrix
<b>Display color</b>	16,777,216 colors (6bit+FRC)
<b>Pixel</b>	1,024 (H) x 768 (V) pixels
<b>Pixel arrangement</b>	RGB (Red dot、Green dot、Blue dot) vertical stripe
<b>Dot pitch</b>	0.099 (W) x 0.297 (H) mm
<b>Pixel pitch</b>	0.297 (W) x 0.297 (H) mm
<b>Module size</b>	326.50 ± 0.5 (W) x 253.5 ± 0.5 (H) x 11.13 ± 0.5 (D) mm (typ.)
<b>Weight</b>	1000 g (typ.)
<b>Contrast ratio</b>	600:1 (typ.)
<b>Viewing angle</b> (At the contrast ratio 10: 1)	<ul style="list-style-type: none"> <li>• Horizontal: 160° (typ.)</li> <li>• Vertical: 160° (typ.)</li> </ul>
<b>Designed viewing direction</b>	• Viewing angle with optimum grayscale ( $\gamma = 2.2$ ): normal axis
<b>Color gamut</b>	At LCD panel center 60 % (typ.) [against NTSC color space]
<b>Response time</b>	$T_{on}$ (white 90% → black 10%) + $T_{off}$ (black 10% → white 90%) 8 ms (typ.)
<b>Luminance</b>	At $IBL = 7mArms / lamp$ 250cd/m <sup>2</sup> (typ.)
<b>Transmissive Mode</b>	Normally White
<b>Surface Treatment</b>	AG Type
<b>Signal system</b>	LVDS 1port [ RGB :8-bit, Dot clock (CLK), Data enable (DE)]
<b>Power supply voltage</b>	LCD panel signal processing board: 3.3V
<b>Backlight</b>	Edge light type: 2 cold cathode fluorescent lamps
<b>Power consumption</b>	At $IBL=7mArms / lamp$ and checkered flag pattern (10.1 )W (typ.)

### 3. BLOCK DIAGRAM

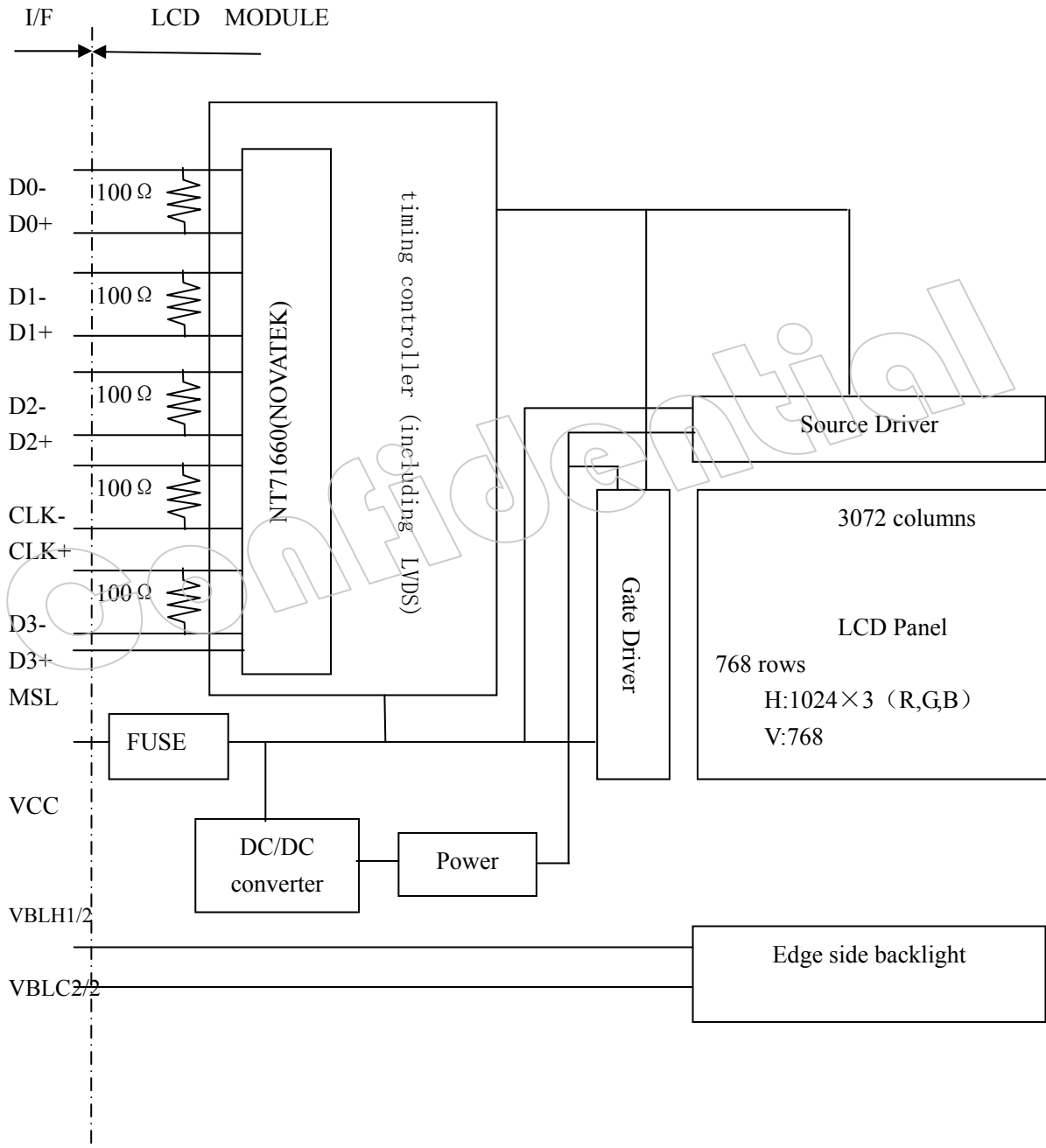

Note1: Connections between GND, FG (Frame ground) and VBLC (Lamp low voltage terminal) in the product

GND - FG	Connected
GND - VBLC	Not connected
FG - VBLC	Not connected

Note2: These grounds should be connected together in customer equipment.

## 4. DETAILED SPECIFICATION

### 4.1 MECHANICAL SPECIFICATIONS

Parameter	Specification	Unit
Module size	326.5±0.5 (W) x 253.5±0.5 (H) x 11.13±0.5 (D) Note1	mm
Display area	304.128 (W) x 228.096 (H) Note1	mm
Weight	1000 (typ.)	g

Note1: See “10. OUTLINE DRAWINGS”.

### 4.2 ABSOLUTE MAXIMUM RATINGS

Parameter	Symbol	Rating	Unit	Remarks	
Power supply voltage	VCC	-0.3 to +3.6	V	Ta = 25°C	
Input voltage for signals	Display signals Note1	-0.3 to +3.6 and Vi < VCC + 0.3	V	Ta = 25°C	
	Function signals Note2				
Storage temperature	Tst	-20 to +60	°C	-	
Operating temperature	Front surface	TopF	0 to +50	°C	Note3
	Rear surface	TopR	0 to +55	°C	Note4
Relative humidity Note5	RH	≤ 95	%	Ta ≤ 40°C	
		≤ 85	%	40 < Ta ≤ 50°C	
Absolute humidity Note6	AH	≤ 70 Note6	g/m <sup>3</sup>	Ta > 50°C	

Note1: Display signals are D0+/-, D1+/-, D2+/-, D3+/- and CK+/-.

Note2: Function signal is MSL.

Note3: Measured at center of LCD panel surface (including self-heat)

Note4: Measured at center of LCD module's rear shield surface (including self-heat)

Note5: No condensation

Note6: Ta = 50°C, RH = 85%

### 4.3 ELECTRICAL CHARACTERISTICS

#### 4.3.1 Driving for LCD panel signal processing board

Parameter	Symbol	min.	typ.	max.	Unit	Remarks	
Power supply voltage	VCC	3.0	3.3	3.6	V	-	
Power supply current	ICC	-	(500)※1	(700)※2	mA	at VCC = 3.3V	
Permissible ripple voltage	VRP	-	-	100	mV	For VCC	
Differential input threshold voltage for LVDS receiver	Low	VTL	-100	-	mV	at VCM = 1.2V Note3	
	High	VTH	-	-	100		mV
Input voltage width for LVDS receiver	Vi	0	-	2.4	V	-	
Terminating resistor	RT	-	100	-	Ω	-	
Input voltage for MSL signal	Low	VFL	0	-	0.8	V	-
	High	VFH	2.0	-	VCC	V	

※1: Checkered flag pattern (EIAJ ED-2522);

※2: 2H1V dot inverse pattern

※3: Common mode voltage for LVDS receiver

#### 4.3.2 Driving for backlight lamp

Parameter	Symbol	min.	typ.	max.	Unit	Remarks
Lamp current	I1	3.5	7.0	7.5	mA <sub>rms</sub>	at L = 250cd/ m <sup>2</sup> (typ.)
Lamp voltage	V1	549	610	671	V <sub>rms</sub>	For each lamp
Lamp starting voltage Note1	VS	-	-	1600	V <sub>rms</sub>	Ta = 0°C Note2
		-	-	1100	V <sub>rms</sub>	Ta = 25°C Note2
Oscillation frequency	FO	40	50	60	kHz	Note3

Note1: The value is the characteristic of lamp. The starting voltage of inverter should be lower than the value. But the possibility of not lighting exists by the lower voltage, so the suitable voltage should be considered by the test.

Note2: The asymmetric ratio of working waveform for lamps (Lamp voltage peak ratio, Lamp current peak ratio and waveform space ratio) should be less than 5% (See the following figure). If the waveform is asymmetric, DC (Direct current) element applies into the lamp. In this case, a lamp lifetime may be shortened, because a distribution of a lamp enclosure substance inclines toward one side between low voltage terminal (Cold terminal) and high voltage terminal (Hot terminal).

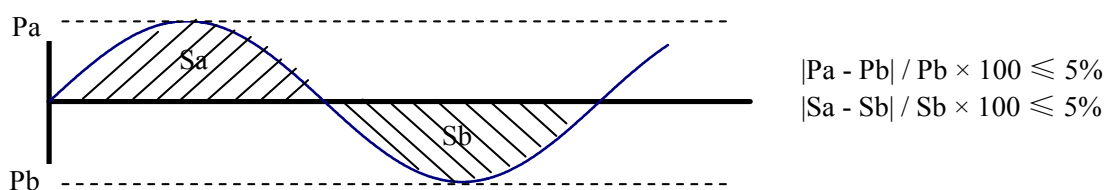

Pa: Supply voltage/current peak for positive, Pb: Supply voltage/current peak for negative

Sa: Waveform space for positive part, Sb: Waveform space for negative part

Note3: Recommended value of "FO" is as following.

$$FO = 1/4 \times 1/\text{th} \times (2n-1) \quad n: \text{Natural number } (1, 2, 3 \dots)$$



## 4.4 POWER SUPPLY VOLTAGE SEQUENCE

### 4.4.1 The sequence of backlight and power supply

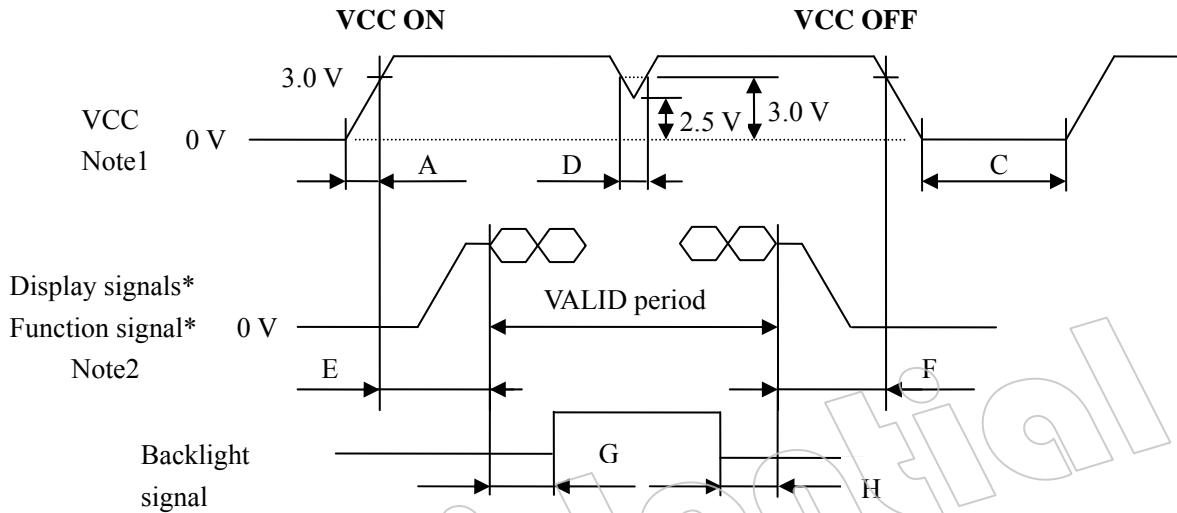

\* These signals should be measured at the terminal of 100Ω resistor.

Parameter		Symbol	min.	typ.	max.	Unit	Remarks
Input voltage sequence	ON	A	-	-	10	ms	-
	Moment	C	500	-	-	ms	-
	DIP	D	-	-	20	ms	※1
Power supply and signal sequence	ON	E	0.01	-	50	ms	-
	OFF	F	0.01	-	50	ms	-
B/L igniting	ON	G	200	-	-	ms	PSWG
B/L extinguishing	OFF	H	200	-	-	ms	-

※ 1: VCC should be 2.5 V or more while VCC ON period.

#### [NOTE ITEM]

Note1: In terms of voltage variation (voltage drop) while VCC rising edge is below 3.0 V, a protection circuit may work, and then this product may not work.

Note2: Display signals (D0+/-, D1+/-, D2+/-, D3+/- and CK+/-) and function signal (MSL) must be "0" voltage, exclude the VALID period (See above sequence diagram). If these signals are higher than 0.3 V, the internal circuit is damaged.

If some of display and function signals of this product are cut while this product is working, even if the signal input to it once again, it might not work normally. If customer stops the display and function signals, they should be cut VCC.

Note3: The backlight power supply voltage should be inputted within the valid period of display and function signals, in order to avoid unstable data display.

Note4: In order to prevent unstable data displaying, suggest that, during display and function signal's valid period, backlight power voltage should be input under the custom ' condition as possible.

### 4.4.2 Power supply voltage ripple

This product works, even if the ripple voltage levels are beyond the permissible values as the following table, but there might be noise on the display image.

Parameter	Power supply voltage	Ripple voltage (Measured at input terminal of power supply)	Note1	Unit
VCC	3.3 V	≤ 100		mVp-p

Note1: The permissible ripple voltage includes spike noise.

#### 4.4.3 Fuse

Parameter	Fuse		Rating	Fusing current	Remarks
	Type	Supplier			
VCC	TF16SN2.50	KOA Corporation	1.5 A	5.0 A	Note1
			32 V		

Note1: The power supply capacity should be more than the fusing current. If the power supply capacity is less than the fusing current, the fuse may not blow for a short time, and then nasty smell, smoking and so on may occur.

## 4.5 CONNECTIONS AND FUNCTIONS FOR INTERFACE PINS

### 4.5.1 LCD panel signal processing board

CN1 socket(Module side): DF-14H-20P-1.25H (Hirose Electric Co., Ltd.)

Adaptable plug: DF14-20S-1.25C (Hirose Electric Co., Ltd.)

Pin No.	Symbol	Signal	Remarks
1	VCC	Power supply	-
2	VCC		
3	GND	Ground	-
4	GND		
5	D0-	Pixel data	Note2
6	D0+		
7	GND	Ground	-
8	D1-		
9	D1+	Pixel data	Note2
10	GND		
11	D2-	Pixel data	Note2
12	D2+		
13	GND	Ground	-
14	CLK-		
15	CLK+	Pixel clock	Note2
16	GND		
17	D3-	Pixel data	Note2
18	D3+		
19	GND	Ground	-
20	MSL		

Low or Open: NOTE1

Note1: See“4.5.4 Connection between receiver and transmitter For LVDS” .

Note2: Twist pair wires with 100Ω(Characteristic impedance) should be connected between LCD panel signal processing board and LVDS transmitter.

#### 4.5.2 Backlight lamp

**Attention: VBLH and VBLC must be connected correctly. IF customer connects wrongly, customer will be hurt and the product will be broken.**

CN201 plug (LCD module side): BHR-03VS-1 (J.S.T Mfg. Co., Ltd.)

Adaptable socket: SM02 (8.0) B-BHS-1-TB (J.S.T Mfg. Co., Ltd.)

Pin No.	Symbol	signal	remarks
1	VBLH	High voltage terminal(Hot)	Cable color: (Sky)Blue
2	N.C	-	-
3	VBLC	Low voltage terminal(Cold)	Cable color: White

CN202 plug (LCD module side): BHR-03VS-1 (J.S.T Mfg. Co., Ltd.)

Adaptable socket: SM02 (8.0) B-BHS-1-TB (J.S.T Mfg. Co., Ltd.)

Pin No.	Symbol	signal	remarks
1	VBLH	High voltage terminal(Hot)	Cable color: (Sky)Blue
2	N.C	-	-
3	VBLC	Low voltage terminal(Cold)	Cable color: White

#### 4.5.3 Position of plugs and a socket

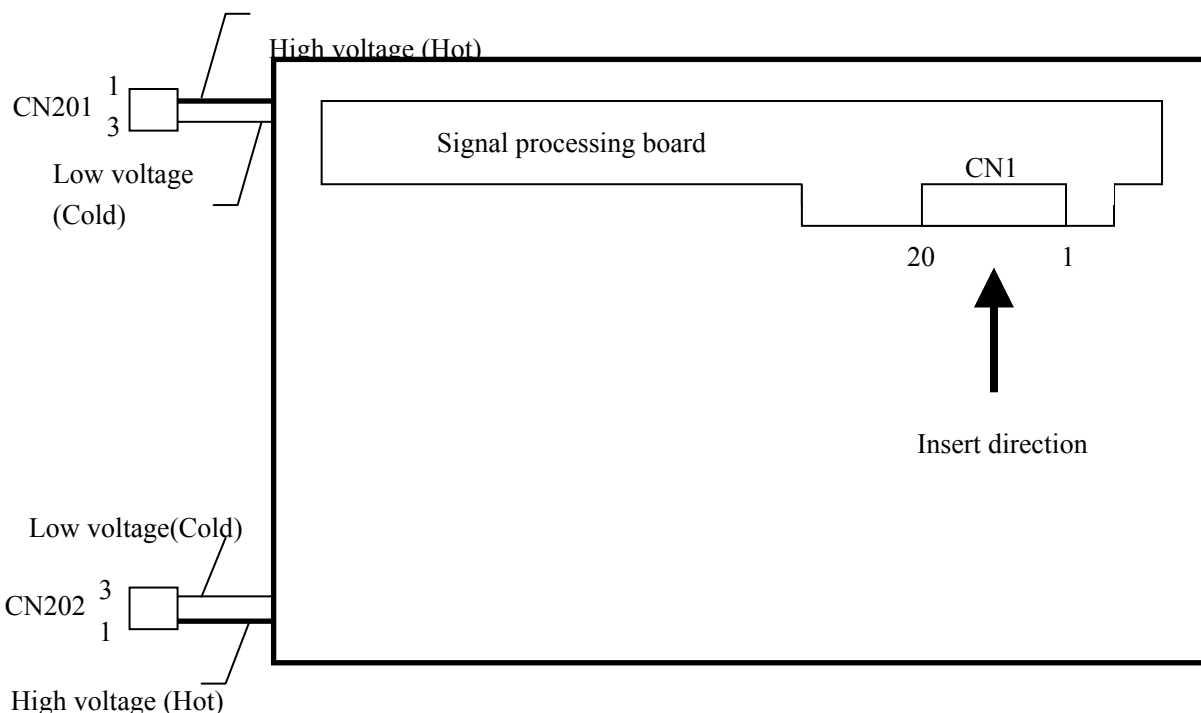

## 4.5.4 Connection between receiver and transmitter for LVDS

Input LVDS map (MSL : "Low" or "Open")

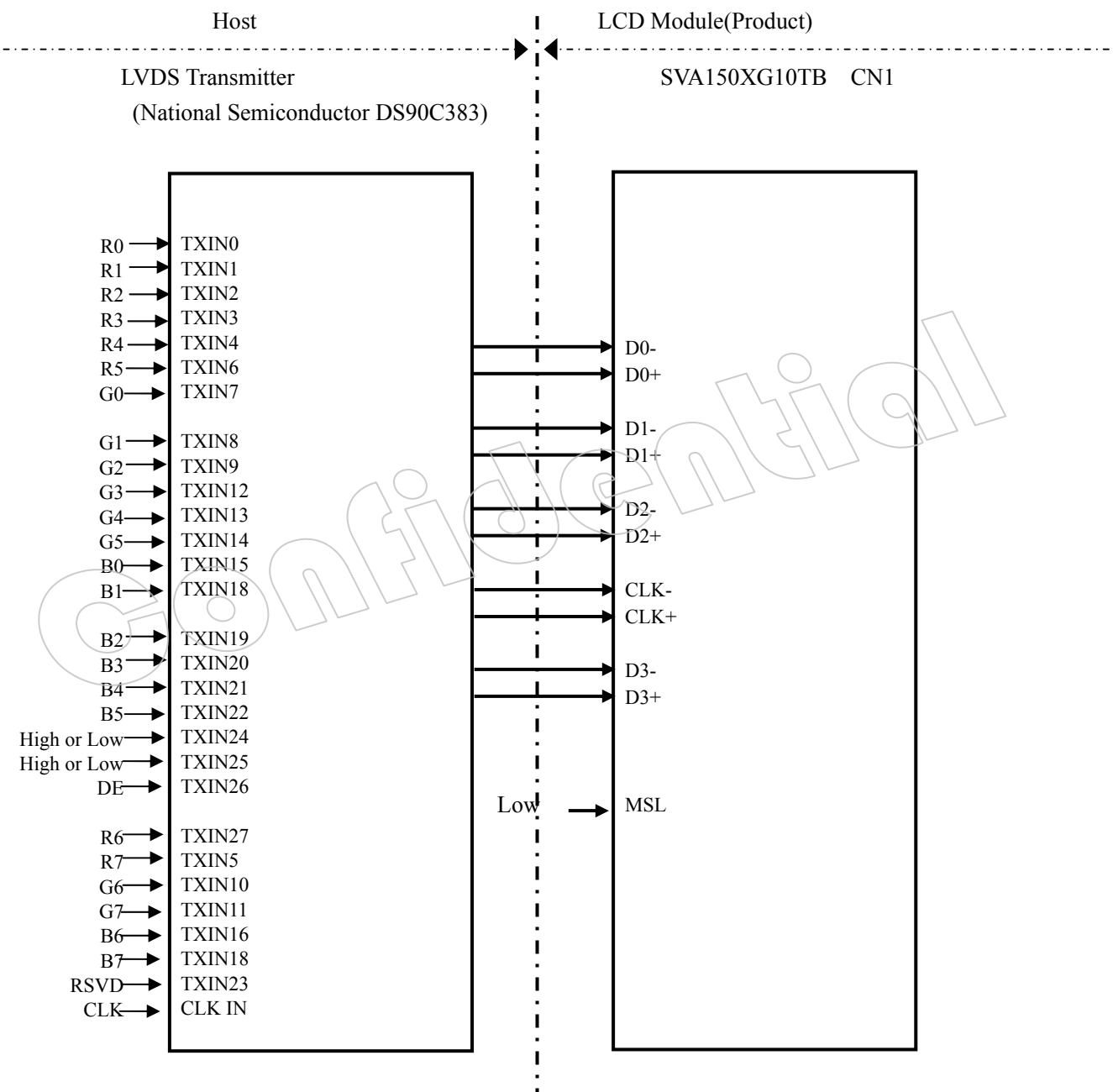

Note1: Recommended transmitter

See the data sheet for DS90C383 (National Semiconductor) .

Note2: LSB (Least Significant Bit) -R0,G0,B0 MSB (Most Significant Bit) -R7,G7,B7

#### 4.6 DISPLAY COLORS AND INPUT DATA SIGNALS

This product can display in equivalent to 16,777,216 colors in 256 scale. Also the relation between display colors and input data signals is as the following table.

Display colors		Data signal (0:Low level, 1:High Level)																							
		R7	R6	R5	R4	R3	R2	R1	R0	G7	G6	G5	G4	G3	G2	G1	G0	B7	B6	B5	B4	B3	B2	B1	B0
Basic Color	Black	0	0	0	0	0	0	0	0	0	0	0	0	0	0	0	0	0	0	0	0	0	0	0	0
	Blue	0	0	0	0	0	0	0	0	0	0	0	0	0	0	0	0	1	1	1	1	1	1	1	1
	Red	1	1	1	1	1	1	1	1	0	0	0	0	0	0	0	0	0	0	0	0	0	0	0	0
	Magenta	1	1	1	1	1	1	1	1	0	0	0	0	0	0	0	0	1	1	1	1	1	1	1	1
	Green	0	0	0	0	0	0	0	0	1	1	1	1	1	1	1	1	0	0	0	0	0	0	0	0
	Cyan	0	0	0	0	0	0	0	0	1	1	1	1	1	1	1	1	1	1	1	1	1	1	1	1
	Yellow	1	1	1	1	1	1	1	1	1	1	1	1	1	1	1	1	0	0	0	0	0	0	0	0
	White	1	1	1	1	1	1	1	1	1	1	1	1	1	1	1	1	1	1	1	1	1	1	1	1
Red grayscale	Black	0	0	0	0	0	0	0	0	0	0	0	0	0	0	0	0	0	0	0	0	0	0	0	
		0	0	0	0	0	0	1	0	0	0	0	0	0	0	0	0	0	0	0	0	0	0	0	
	Dark	0	0	0	0	0	0	1	0	0	0	0	0	0	0	0	0	0	0	0	0	0	0	0	
	Bright	1	1	1	1	1	1	0	1	0	0	0	0	0	0	0	0	0	0	0	0	0	0	0	
Red	1	1	1	1	1	1	1	0	0	0	0	0	0	0	0	0	0	0	0	0	0	0	0		
	1	1	1	1	1	1	1	0	0	0	0	0	0	0	0	0	0	0	0	0	0	0	0		
Green grayscale	Black	0	0	0	0	0	0	0	0	0	0	0	0	0	0	0	0	0	0	0	0	0	0	0	
		0	0	0	0	0	0	0	0	0	0	0	0	0	0	1	0	0	0	0	0	0	0	0	
	Dark	0	0	0	0	0	0	0	0	0	0	0	0	0	1	0	0	0	0	0	0	0	0	0	
	Bright	0	0	0	0	0	0	0	1	1	1	1	1	1	0	1	0	0	0	0	0	0	0	0	
Green	0	0	0	0	0	0	0	1	1	1	1	1	1	1	0	0	0	0	0	0	0	0	0		
	0	0	0	0	0	0	0	1	1	1	1	1	1	1	1	0	0	0	0	0	0	0	0		
Blue grayscale	Black	0	0	0	0	0	0	0	0	0	0	0	0	0	0	0	0	0	0	0	0	0	0	0	
		0	0	0	0	0	0	0	0	0	0	0	0	0	0	0	0	0	0	0	0	0	0	1	
	Dark	0	0	0	0	0	0	0	0	0	0	0	0	0	0	0	0	0	0	0	0	0	1	0	
	Bright	0	0	0	0	0	0	0	0	0	0	0	0	0	0	0	1	1	1	1	1	1	0	1	
Blue	0	0	0	0	0	0	0	0	0	0	0	0	0	0	0	1	1	1	1	1	1	1	0		
	0	0	0	0	0	0	0	0	0	0	0	0	0	0	0	1	1	1	1	1	1	1	1		

## 4.7 DISPLAY POSITIONS

The following table is the coordinates per pixel

$C(1, 1)$   

R	G	B
---	---	---

$C(1, 1)$	$C(2, 1)$	...	$C(X, 1)$	...	$C(1023, 1)$	$C(1024, 1)$
$C(1, 2)$	$C(2, 2)$	...	$C(X, Y)$	...	$C(1023, 2)$	$C(1024, 2)$
•	•	•	•	•	•	•
•	•	•	•	•	•	•
•	•	•	•	•	•	•
$C(1, Y)$	$C(2, Y)$	...	$C(X, Y)$	...	$C(1023, Y)$	$C(1024, Y)$
•	•	•	•	•	•	•
•	•	•	•	•	•	•
•	•	•	•	•	•	•
$C(1, 767)$	$C(2, 767)$	...	$C(X, 767)$	...	$C(1023, 767)$	$C(1024, 767)$
$C(1, 768)$	$C(2, 768)$	...	$C(X, 768)$	...	$C(1023, 767)$	$C(1024, 768)$

## 4.8 INPUT SIGNAL TIMINGS FOR LCD PANEL SIGNAL PROCESSING BOARD

### 4.8.1 Outline of input signal timings

#### • Horizontal signal

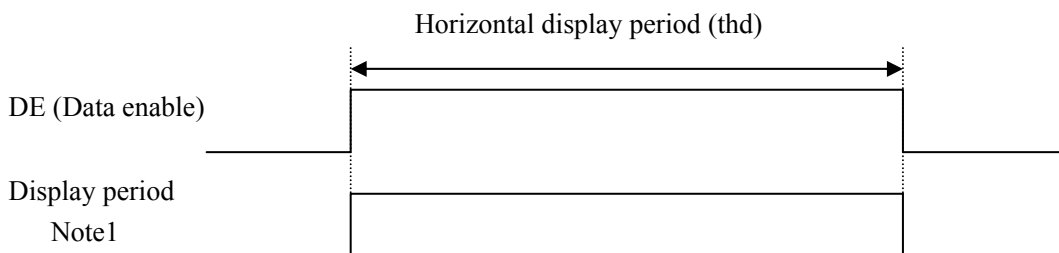

Note1: This diagram indicates virtual signal for set up to timing.

#### • Vertical signal

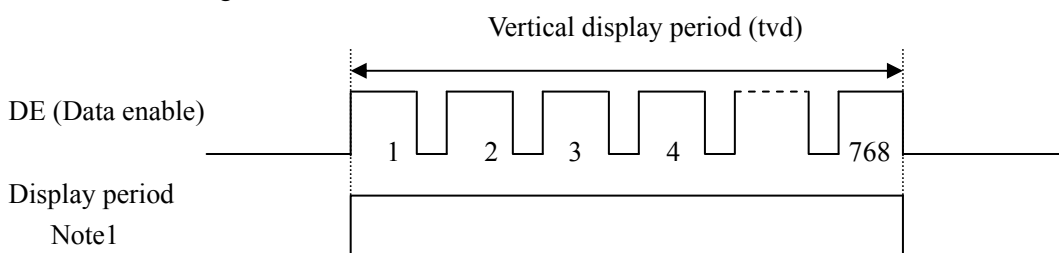

Note1: This diagram indicates virtual signal for set up to timing.

## 4.8.2 Timing characteristics

(Note1)

Parameter		Symbol	min.	typ.	max.	Unit	Remarks		
CLK	Frequency	1/tc	60.0	65.0	70.0	MHz	15.384ns (typ.)		
	Duty	—	—			—	Note2		
	Rise time, Fall time	—	—			ns			
DATA	CLK-DATA	Setup time	—	—			ns	Note2	
		Hold time	—	—			ns		
	Rise time, Fall time	—	—			ns			
DE	Horizontal	Cycle	th	12.3	20.676	30.00	μs	48.363KHz(typ.) Note3 Note4	
				1050	1344	1800	CLK		
	Vertical (One frame)	Cycle	tv	1024				—	
				13.1	16.666	20.0	ms	60.0Hz (typ.)	
	Display period	tvd	770			806	1334		H
			768						H
CLK-DE	Setup time	—	—			ns	Note2		
		—	—			ns			
	Rise time, Fall time	—	—			ns			

Note1: Definition of parameters is follows.

$$tc=1CLK, Th=1H$$

Note 2: See the data sheet of LVDS transmitter.

Note 3: Both of “time” and “CLK number” of the “th” must keep the Minimum value of specifications.

Note 4: “th” must keep the fluctuation within  $\pm 1$  CLK, because of avoidance of image sticking.

## 4.8.3 Input signal timing chart

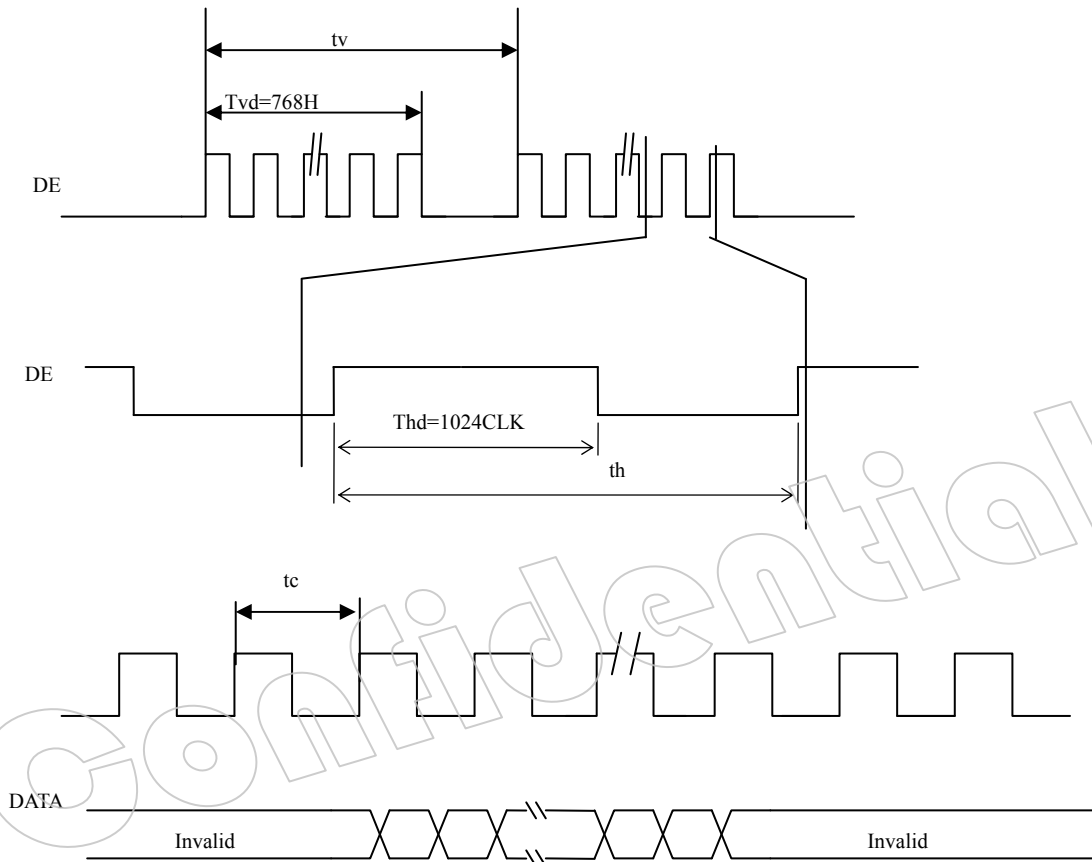



## 4.9 OPTICS

### 4.9.1 Optical characteristics

Parameter Note1	Condition	Symbol	min.	typ.	max.	Unit	
Luminance	White at center R=0, L=0, U=0,D=0	L	200	250	-	cd/ m <sup>2</sup>	
Contrast ratio	White/Black at center R=0, L=0, U=0,D=0	CR	400	600	-	-	
Luminance uniformity	-	LU	-	1.2	1.3	-	
Chromaticity	White	X coordinate	Wx	0.283	0.313	0.343	-
		Y coordinate	Wy	0.299	0.329	0.359	-
	Red	X coordinate	Rx	0. 60	0. 63	0. 66	-
		Y coordinate	Ry	0. 31	0.34	0. 37	-
	Green	X coordinate	Gx	0. 27	0.30	0. 33	-
		Y coordinate	Gy	0. 54	0.57	0. 60	-
	Blue	X coordinate	Bx	0. 11	0.14	0. 17	-
		Y coordinate	By	0. 07	0.10	0. 13	-
Color gamut	R=0, L=0, U=0,D=0	C	50	60	-	%	
Response time	White to black	Ton	-	2	4	ms	
	Black to white	Toff	-	6	8	ms	
Viewing angle	Right	$\theta U=0^\circ, \theta D=0^\circ, CR=10$	$\theta R$	70	80	-	°
	Left	$\theta U=0^\circ, \theta D=0^\circ, CR=10$	$\theta L$	70	80	-	°
	Up	$\theta R=0^\circ, \theta L=0^\circ, CR=10$	$\theta U$	70	80	-	°
	Down	$\theta R=0^\circ, \theta L=0^\circ, CR=10$	$\theta D$	70	80	-	°

Note1: Measurement conditions are follows.

Ta=25C, VCC=3.3V, IBL=7mArms/lamp, Display mode: XGA, Horizontal cycle=48.363 KHz,  
Vertical cycle=60.000Hz

Optical characteristics are measured at luminance saturation after 20minutes from working the product, in the dark room. Also measurement method for luminance is as follows.

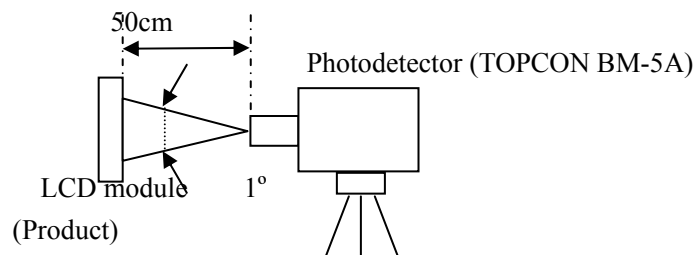

Note 2: See“4.10.2 Definition of contrast ratio”.

Note 3: See“4.10.3 Definition of luminance uniformity”.

Note 4: Product surface temperature: TopF=28.0°C

Note 5: See “4.10.4 Definition of response times”.

Note 6: See “4.10.5 Definition of viewing angles”.

#### 4.9.2 Definition of contrast ratio

The contrast ratio is calculated by using the following formula.

$$\text{Contrast ratio (CR)} = \frac{\text{Luminance of white screen}}{\text{Luminance of black screen}}$$

#### 4.9.3 Definition of luminance uniformity

The luminance uniformity is calculated by using the following formula.

$$\text{Luminance uniformity (LU)} = \frac{\text{Maximum luminance from ① to ⑨}}{\text{Minimum luminance from ① to ⑨}}$$

The luminance is measured at near the 5 points shown below.

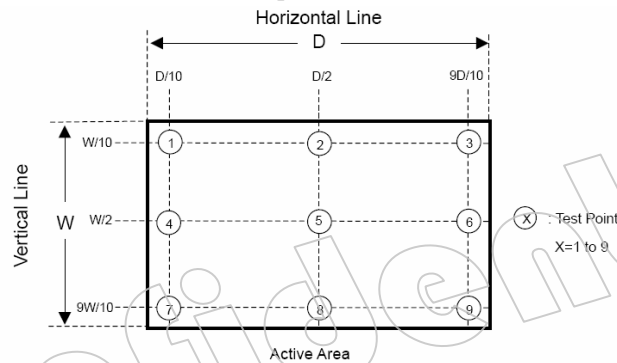

#### 4.9.4 Definition of response times

Response time is measured, the luminance changes from “white” to “black”, or “black” to “white” on the same screen point, by photo-detector. Ton is the time it takes the luminance change from 90% down to 10%. Also Toff is the time it takes the luminance change from 10% up to 90%. (See the following diagram.)

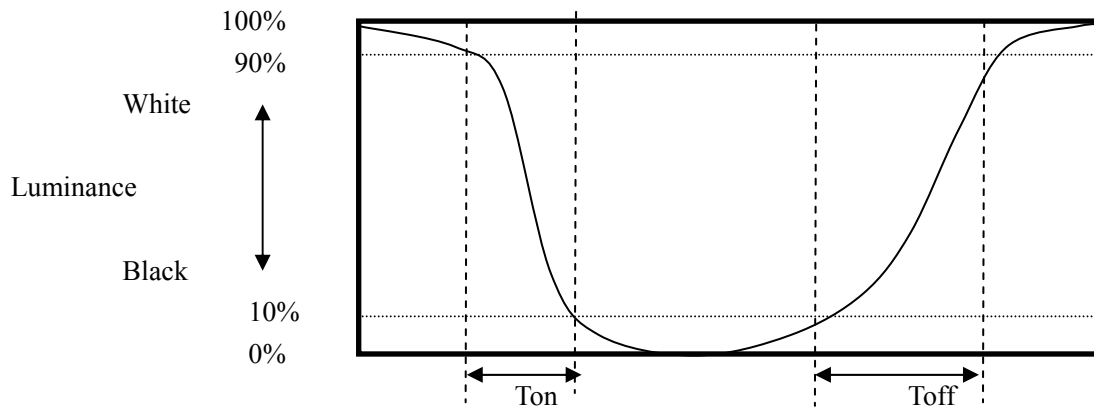

#### 4.9.5 Definition of viewing angles

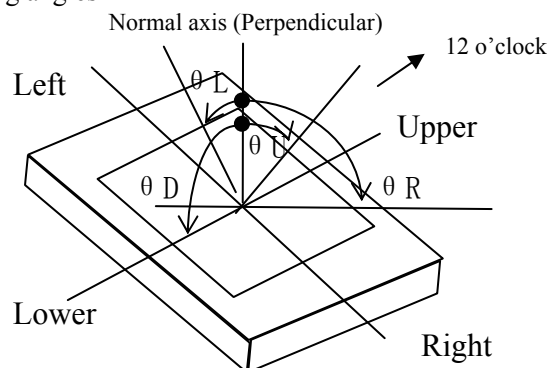

## 5. RELIABILITY TESTS

Test item	Condition	Judgement	Note1
High temperature and humidity(Operation)	① 50±2℃,RH=85%,240hours ② Display data is black	No display malfunctions	
Heat cycle (Operation)	① 0±3℃...1hour 55±3℃...1hour ② 50cycles,4hours/cycle ③ Display data is black		
Thermal shock (Non operation)	① -20±3℃...30minutes 60±3℃...30minutes ② 100cycles,1hour/cycle ③ Temperature transition time is within 5 minutes.		
ESD (operation)	① 150Pf,150Ω,±10kV ② 9 places on a panel surface ③ 10 times each places at 1 sec interval		
Dust (operation)	① Sample dust: No.15(byJIS-Z8901) ② 15 seconds stir ③ 8 times repeat at 1 hour interval		
Vibration (Non operation)	① 5-100Hz, sine wave,11.76m/S <sup>2</sup> ② 1 minutes/cycle ③ X,Y,Z direction ④ 50 times each directions		
Mechanical shock (Non operation)	① 294m/S <sup>2</sup> , 11ms ② ±X, ±Y, ±Z direction ③ 3 times each directions		
Low pressure	operation	① 53.3kPa (Equivalent to altitude 4,850m) ② 0℃±3℃...24hours ③ 50℃±3℃...24hours	No display malfunctions
	non-operation	① 15kPa (Equivalent to altitude 13,600m) ② -20℃±3℃...24hours ③ 60℃±3℃... 24hours	

Note1: Display and appearance are checked under environmental conditions equivalent to the inspection conditions of defect criteria.

Note2: See the following figure for discharge points.

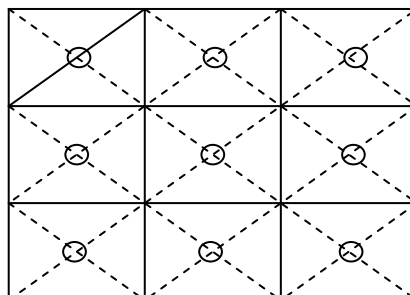

## 6. ESTIMATED LUMINANCE LIFETIME

The luminance lifetime is the time from initial luminance to half-luminance.

**This lifetime is the estimated value, and is not guarantee value.**

Condition		Luminance lifetime(MTTF) Note1,Note2	Unit
Module	25°C(Ambient temperature of the product) Continuous operation and IBL=7mArms/lamp	40,000	h
	50°C(Surface temperature at screen center) Continuous operation and IBL=7mArms/lamp	35,000	h
Cold cathode Fluorescent lamp	25°C(Ambient temperature of the product) Continuous operation and IBL=7mArms/lamp	40,000	h

Note1: MTTF is mean time to half-luminance.

Note2: In case the product works under low temperature environment, the lifetime becomes short.

## 7. MARKINGS

The various markings are attached to this product. See “7.4 INDECATION LOCATIONS” for attachment positions.

### 7.1 PRODUCT LABEL



Note1: The meaning of lot number

• Example: 1111A104201001

1111      A      1      04      9      01      001

Internal use	Revision 1 letter (Alphabet)	Internal use	Manufacturing year 2 figures of the A.D. end numbers (e.g. A.D2004 is 04.)	Manufacturing month 1 letter	Manufacturing day	Production number Multi-letter (figure)
--------------	------------------------------------	--------------	---	---------------------------------	-------------------	---

Note2

Jan. to Sep.: Number of month  
October: A  
November: B  
December: C

Note2: **Do not attach anything such as label and so on, on the product label!** In case repair the product, SVA-NEC needs the contents of product label such as the lot number, inspection date and so on, to identify the warranty period with individual product. If SVA-NEC cannot decipher the contents of product label, such repair shall be entitled to charge. Also SVA-NEC may give a new lot number to reconditioned products.

### 7.2 BARCODE LABEL

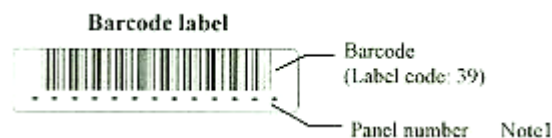

### 7.3 OTHER MARKINGS

High voltage caution marking



Disposal method marking for lamp

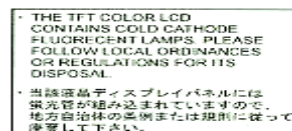

## 7.4 INDICATION LOCATIONS

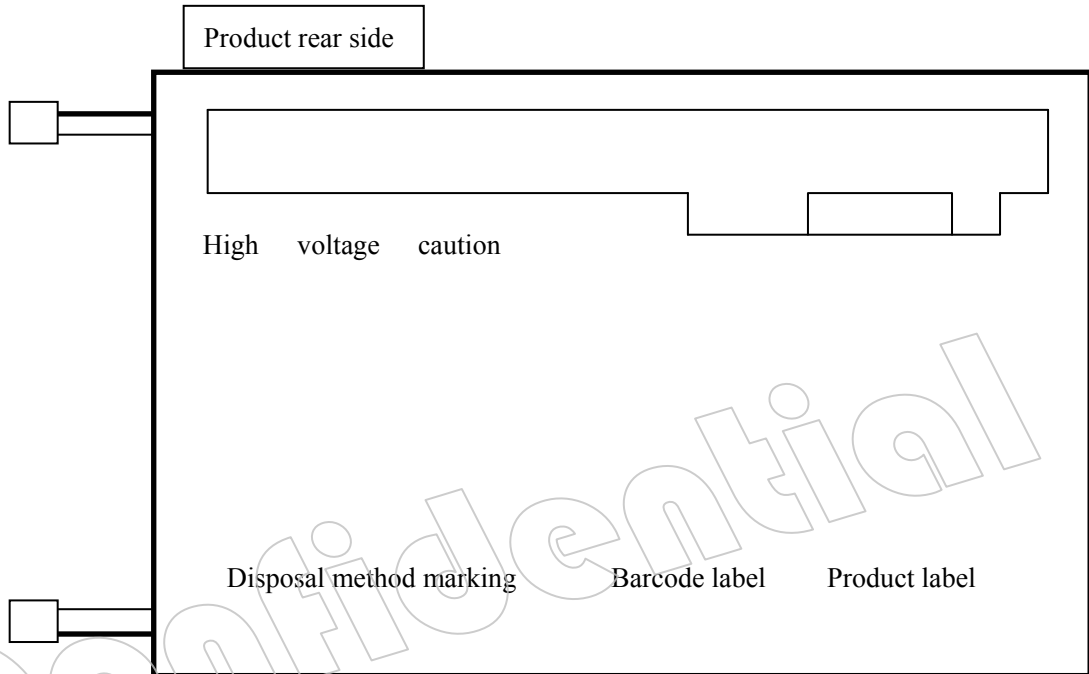

## 8. PACKING, TRANSPORTATION AND DELIVERY

SVA-NEC will pack products to deliver to customer in accordance with SVA-NEC packing specifications, and will deliver products to customer in such a state that products will not suffer from a damage during transportation .The delivery conditions are as follows.

### 8.1 PACKING

#### (1) Packing box

10 products are packed up with the maximum in a packing box(See “**8.5 OUTLINE FIGURE FOR PACKING**”).

Products are put into a plastic bag for prevention of moisture with cushion, and then the bag is sealed up with heat sealing.

The type name and quality are shown on outside of the packing box, either labeling or printing.

#### (2)Pallet Packing (See” **8.5 OUTLINE FIGURE FOR PACKING** “)

- ① Packing boxes are tired on a cardboard pallet.(9 boxes×4 tiers maximum)
- ②Cardboard sleeve and top cap are attached to the packing boxes, then they are fixed by a band.

### 8.2 INSPECTION RECORD SHEET

Inspection record sheets are included in the packing box with delivery products to customer. It is summarized to a number of products for pass/fail assessment.

### 8.3 TRANSPORTATION

The product is transported by vehicle, aircraft or shipment in the state of pallet packing.

### 8.4 SIZE AND WEIGHT FOR PACKING BOX

Parameter	Packing box	Unit
Size	319 (L) x374 (W) x407 (H) (typ.)	mm
Weight	1.6 (typ.)	kg
Total weight	13.6 (typ.) (with 10 products)	kg

### 8.5 OUTLINE FIGURE FOR PACKING

(1) Packing box

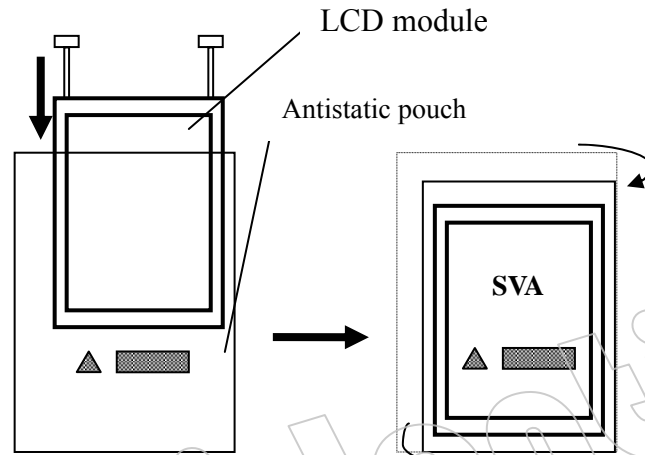

Confidential

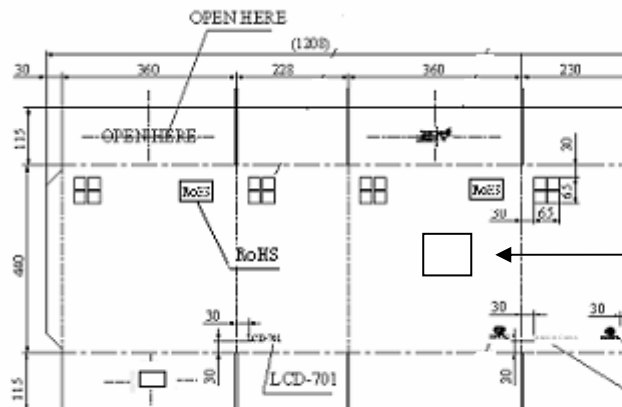
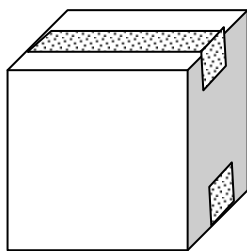
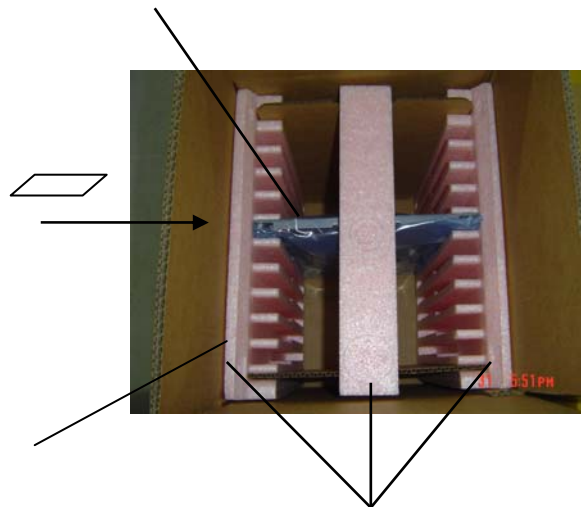

**TFT-LCD MODULE**   
薄膜晶体管液晶显示模块

Model 型号: SVA150XG10TB  
Bus No. 箱号 

Lot No.(批号)	QTY(数量)
	10 pcs

MADE IN CHINA



(2) Pallet packing

Note: The ways for Packing and Shipping vary from different shipment volume, dependent on specific situations.

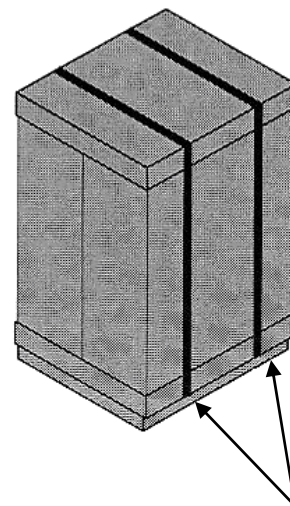
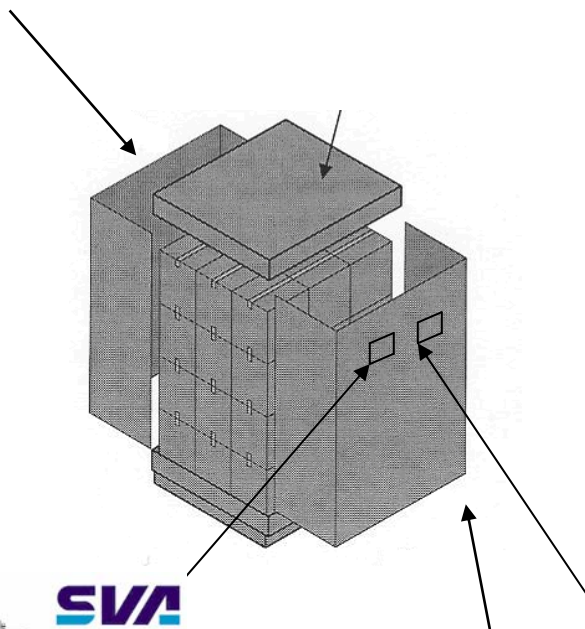
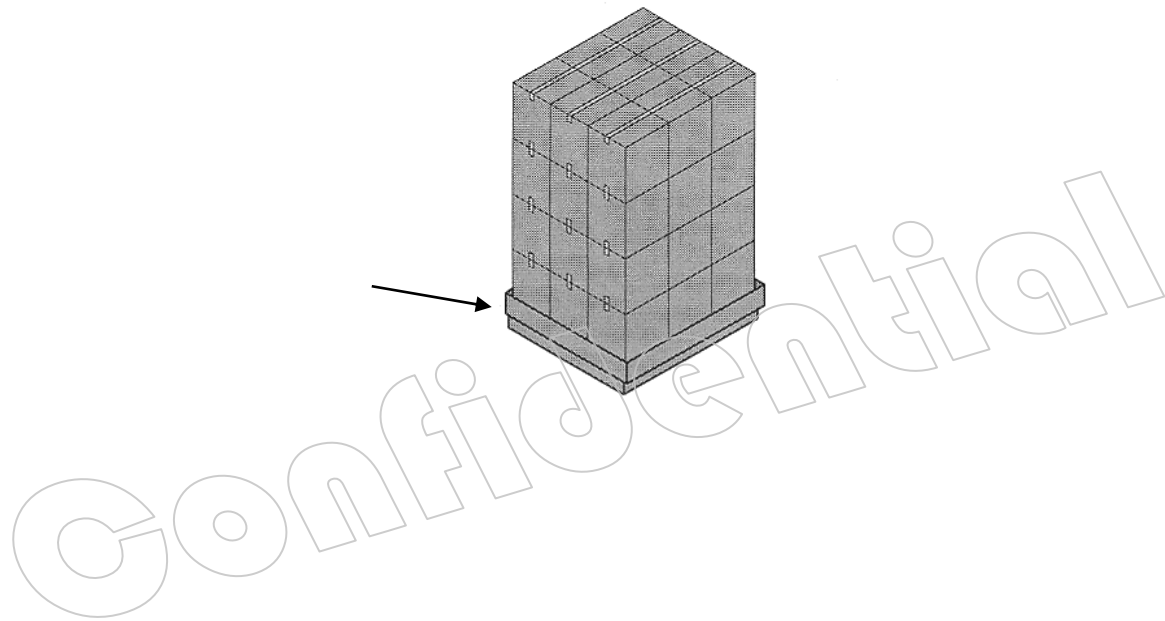

**SVA**

Product Name: 15 TFT-LCD Module  
 Product Code: SVA150XG10EB  
 Client: TPV  
 Catalog No.: T50LLD50-4TB  
 Release Date: 15<sup>th</sup> Sep. 2005

Separator: \*\*40K  
 Revision: K  
 Qty: 360 Pcs.

Plate No.:  
 5X004A7K5919A001

MADE IN CHINA

Lot No.	Quantity	Lot No.	Quantity
112003910001	240pcs		
112003910002	120pcs		

## 9. PRECAUTIONS

### 9.1 MEANING OF CAUTION SIGNS

The following caution signs have very important meaning. **Be sure to read “9.2 CAUTIONS” and “9.3 ATTENTIONS”, after understanding these contents!**



This sign has the meaning that customer will be injured by himself or the product will sustain a damage, if customer has wrong operations.



This sign has the meaning that customer will get an electrical shock, if customer has wrong operations.



This sign has the meaning that customer will be injured by himself, if customer has wrong operations.

### 9.2 CAUTIONS



**\* Do not touch lamp cables while turn on. Customers will be in danger of an electric shock**



**\* Do not touch the working backlight and IC. Customers will be in danger of burn injury.**  
**\* Do not shock and press the LCD panel and the backlight! There is a danger of breaking, because they are made of glass.(shock :To be not greater 294m/s<sup>2</sup> and to be not greater 11ms, Pressure: To be not greater 19.6N)**

### 9.3 ATTENTIONS



#### 9.3.1 Handling of the product

- ① Take hold of both ends without touch the circuit board when customer pulls out products (LCD modules) from inner packing box. If customer touches it, products may be broken down or out of adjustment, because of stress to mounting parts.
- ② Do not hook cables nor pull connection cables such as flexible cable and so on, for fear of damage.
- ③ If customer puts down the product temporarily, the product puts on flat subsoil as a display side turns down.
- ④ Take the measures of electrostatic discharge such as earth band, ionic shower and so on, when customer deal with the product, because products may be damaged by electrostatic.
- ⑤ The torque for mounting screws must never exceed 0.34N·m. Higher torque values might result in distortion of the bezel.
- ⑥ The product must be installed using mounting holes without undue stress such as bends or twist (See outline drawings). And do not add undue stress to any portion (such as bezel flat area) except mounting hole portion. Bends or twist described above and undue stress to any portion except mounting hole portion may cause display

un-uniformity.

- ⑦ Do not press or rub on the sensitive display surface .If customer clean on the panel surface, SVA-NEC recommends using the cloth with ethanolic liquid such as screen cleaner for LCD.
- ⑧ Do not push-pull the interface connectors while the product is working, because wrong power sequence may break down the product.
- ⑨ Do not bend or unbend the lamp cable at the near part of the lamp holding rubber, to avoid the damage for high voltage side of the lamp. This damage may cause a lamp breaking and abnormal operation of high voltage circuit.

### 9.3.2 Environment

- ① Do not operate or store in high temperature, high humidity, dewdrop atmosphere or corrosive gases. Keep the product in antistatic pouch in room temperature, because of avoidance for dusts and sunlight, if customer stores the product.
- ② In order to prevent dew condensation occurring by temperature difference, the product packing box must be opened after leave under the environment of an unpacking room temperature enough. Because a situation of dew condensation occurring is changed by the environment temperature and humidity, evaluate the leaving time sufficiently. (Recommendation leaving time: 6 hour or more with packing state)
- ③ Do not operate in a high magnetic field .Circuit boards may be broken down by it.
- ④ This product is not designed as radiation hardened.
- ⑤ Use an original protection sheet on the product surface (polarizer). Adhesive type protection sheet should be avoided, because it may change color or properties of the polarizer.

### 9.3.3 Characteristics

**The following items are neither defects nor failures.**

- ① Response time, luminance and color may be changed by ambient temperature.
- ②The LCD may be seemed luminance non-uniformity, flicker, vertical seam or small spot by display patterns.
- ③Optical characteristics (e.g. luminance, display uniformity, etc.) gradually is going to change depending on operating time ,and especially low temperature, because the LCD has cold cathode fluorescent lamps.
- ④Do not display the fixed pattern for a long time because it may cause image sticking .Use a screen saver, if the fixed pattern is displayed on the screen.
- ⑤The display color may be changed by viewing angle because of the use of condenser sheet in the backlight.
- ⑥Optical characteristics may be changed by input signal timings.
- ⑦The interference noise of input signal frequency for this product and luminance control frequency of customer's backlight inverter may appear on a display. Set up luminance control frequency of backlight inverter so that the interference noise doses not appear.

### 9.3.4 Other

- ①All GND and VCC terminals should be used without a non-connected line.
- ②Do not disassemble a product or adjust volume without permission of SVA-NEC.
- ③Pay attention not to insert waste materials inside of products, if customer uses screw nails.
- ④Pack the product with original shipping package, because of avoidance of some damages during transportation, when customer returns it to SVA-NEC for repair and so on .
- ⑤Not only the module but also the equipment should be packed and transported as the module. becomes vertical .Otherwise, there is the fear that a display dignity decreases by an impact or vibrations.



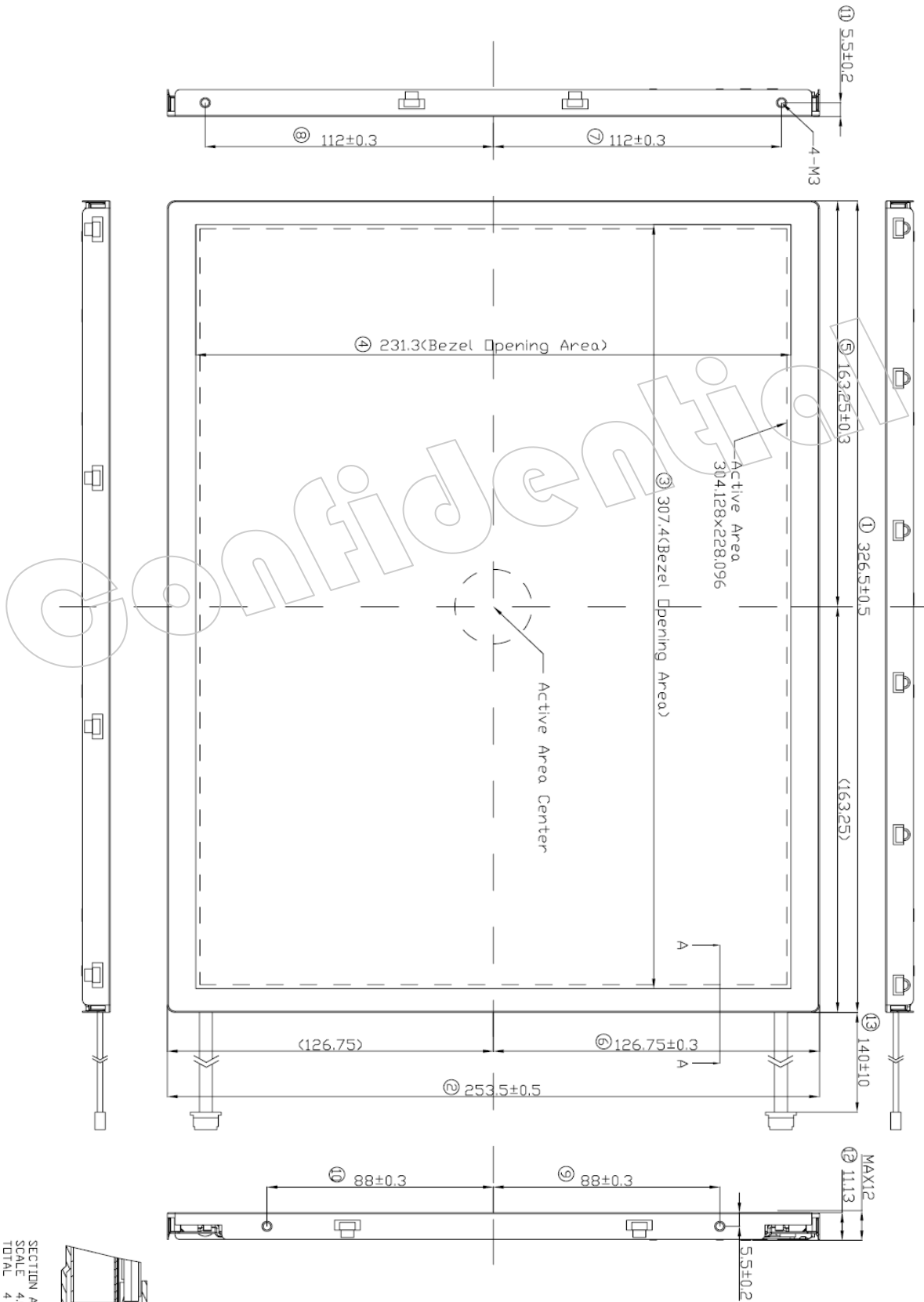



10.OUTDRAWING



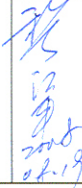

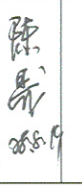
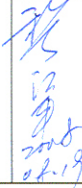
Rev	Revised date	Main Revision item and sign	Approved by	Checked by	Prepared by	Published date									
1.0	2007-4-11	<p style="text-align: center;">New publication</p> <table border="1"> <tr> <td rowspan="2">Sign</td> <td>品管</td> <td>营业</td> <td>产品技术</td> <td>产品验证</td> </tr> <tr> <td>一户</td> <td>许颐璐</td> <td>矢崎</td> <td>杜嘉祥</td> </tr> </table>	Sign	品管	营业	产品技术	产品验证	一户	许颐璐	矢崎	杜嘉祥	Peiying Chen	T-kai	Shu Bingxian 2007-4-11	2007-4-13
Sign	品管	营业		产品技术	产品验证										
	一户	许颐璐	矢崎	杜嘉祥											
2.0	2007-6-5	<table border="1"> <tr> <td rowspan="2">Sign</td> <td>品管</td> <td>营业</td> <td>产品技术</td> <td>产品验证</td> </tr> <tr> <td>黎江平</td> <td>许颐璐</td> <td>矢崎</td> <td>杜嘉祥</td> </tr> </table> <p>Note:</p> <ol style="list-style-type: none"> <li>1. Weight of product in the spec has been changed from 1200 to 1000.(p5&amp;p7)</li> <li>2. The min. of the CR and view angle have been added. (p17)</li> <li>3. The 4.10 DEFECT CRITERIA was moved.. The customer can see it in the IIS.</li> </ol>	Sign	品管	营业	产品技术	产品验证	黎江平	许颐璐	矢崎	杜嘉祥	Peiying Chen	T-kai	Shu Bingxian 2007-6-5	2007-6-6
Sign	品管	营业		产品技术	产品验证										
	黎江平	许颐璐	矢崎	杜嘉祥											

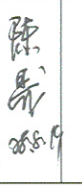
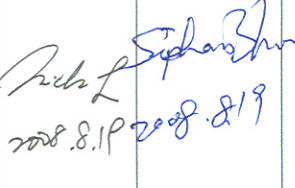
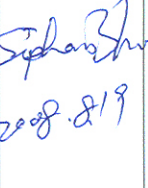
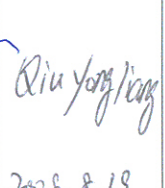
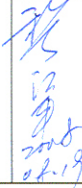
3.0	2007-6-29	<table border="1" data-bbox="343 246 726 537"> <tr> <td rowspan="2">Sign</td> <td>品管</td> <td>营业</td> <td>产品技术</td> <td>产品验证</td> </tr> <tr> <td>黎江平</td> <td>许颐璐</td> <td>矢崎</td> <td>杜嘉祥</td> </tr> </table> <p data-bbox="343 560 845 873"> <b>Note:</b>            1. The view angle of the product(min.,typ.,horizontal,vertical) has been changed.(p5&amp;p17)            2. The 20th pin on signal processing board has been changed.: Input LVDS map A (MSL :”High”) has been added.(p10&amp;p12)         </p>	Sign	品管	营业	产品技术	产品验证	黎江平	许颐璐	矢崎	杜嘉祥	Peiying Chen	T-kai	Shu Bingxian 2007-6-29	2007-6-29
Sign	品管	营业		产品技术	产品验证										
	黎江平	许颐璐	矢崎	杜嘉祥											
4.0	2007-7-23	<table border="1" data-bbox="343 913 726 1227"> <tr> <td rowspan="2">Sign</td> <td>品管</td> <td>营业</td> <td>产品技术</td> <td>产品验证</td> </tr> <tr> <td>黎江平</td> <td>许颐璐</td> <td>矢崎</td> <td>杜嘉祥</td> </tr> </table> <p data-bbox="343 1272 845 1500"> <b>Note:</b>            1. The IBL of backlight was renewed when estimate the life of the lamp. (p21)            2. The LVDS mapping was renewed.(p10)            3. Input voltage sequence(VCC OFF)was moved.(p9)         </p>	Sign	品管	营业	产品技术	产品验证	黎江平	许颐璐	矢崎	杜嘉祥	Peiying Chen	T-kai	Shu Bingxian 2007-7-23	
Sign	品管	营业		产品技术	产品验证										
	黎江平	许颐璐	矢崎	杜嘉祥											
5.0	2007-9-3	<table border="1" data-bbox="343 1538 726 1874"> <tr> <td rowspan="2">Sign</td> <td>品管</td> <td>营业</td> <td>产品技术</td> <td>产品验证</td> </tr> <tr> <td>黎江平</td> <td>许颐璐</td> <td>矢崎</td> <td>杜嘉祥</td> </tr> </table> <p data-bbox="343 1897 845 2116"> <b>Note:</b>            1. “R,G,B” ‘s Chromaticity (Min. &amp; Max) was added to the spec.(p17)            2. Definition of luminance uniformity was changed from “5”point to “9” point.(p18)         </p>	Sign	品管	营业	产品技术	产品验证	黎江平	许颐璐	矢崎	杜嘉祥	Peiying Chen	Zhao Haifeng 2007-9-3	Shu Bingxian 2007-9-3	
Sign	品管	营业		产品技术	产品验证										
	黎江平	许颐璐	矢崎	杜嘉祥											

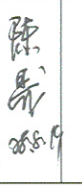
6.0	2008.8.19	<table border="1" data-bbox="354 246 734 609"> <tr> <td></td> <td>品管</td> <td>营业</td> <td>生产管理</td> <td></td> </tr> <tr> <td>Sign</td> <td></td> <td></td> <td></td> <td></td> </tr> </table> <p data-bbox="354 654 857 851">                     Note:                      1、 The general information is renewed.(P5)                      2、 RoHS and TCO items are added.(P4)                 </p>		品管	营业	生产管理		Sign					 2008.8.19	 2008.8.19	 2008.8.19	2008.8.21
	品管	营业	生产管理													
Sign																

Confidential